



LED Clubscanner 20W

ORDERCODE 41390



SHOWELECTRONICS FOR PROFESSIONALS

Congratulations!

You have bought a great, innovative product from Showtec.

The Showtec LED Clubscanner brings excitement to any venue. Whether you want simple plug-&-play action or a sophisticated DMX show, this product provides the effect you need.

You can rely on Showtec, for more excellent lighting products.

We design and manufacture professional light equipment for the entertainment industry.

New products are being launched regularly. We work hard to keep you, our customer, satisfied.

For more information: iwant@showtec.info

You can get some of the best quality, best priced products on the market from Showtec.

So next time, turn to Showtec for more great lighting equipment.

Always get the best -- with Showtec !

Thank you!



Warning	2
Safety-instructions.....	2
Operating Determinations.....	4
Rigging.....	4
Return Procedure.....	5
Claims.....	5
Description	6
Features and Overview	6
Backside.....	7
Installation	7
Set Up and Operation	7
Control Modes.....	8
One LED Clubscanner (Sound Control).....	8
Multiple LED Clubscanners (Master/Slave control).....	8
Multiple LED Clubscanners (DMX control).....	9
Fixture Linking.....	10
Data Cabling.....	10
Dipswitch setting for DMX Mode.....	11
DMX Quick Reference Chart.....	11
DMX Channels.....	13
Optional Remote control (43021).....	14
Channel settings.....	14
Maintenance	15
Replacing the Fuse.....	15
Static Gobowheel and Colorwheel.....	15
Troubleshooting	16
No Light, No Movement - All Products.....	16
No Response to DMX	16
Product Specifications	18

WARNING

**FOR YOUR OWN SAFETY, PLEASE READ THIS USER MANUAL CAREFULLY
BEFORE YOUR INITIAL START-UP!**

Unpacking Instructions

Immediately upon receiving this product, carefully unpack the carton and check the contents to ensure that all parts are present, and have been received in good condition. Notify the dealer immediately and retain packing material for inspection if any parts appear damaged from shipping or the carton itself shows signs of mishandling. Save the carton and all packing materials. In the event that a fixture must be returned to the factory, it is important that the fixture be returned in the original factory box and packing.

Your shipment includes:

- Showtec LED Clubscanner with IEC powercable 0,75m
- User manual



LED Expected Lifespan

LEDs gradually decline in brightness over time. HEAT is the dominant factor that leads to the acceleration of this decline. Packaged in clusters, LEDs exhibit higher operating temperatures than in ideal or singular optimum conditions. For this reason when all color LEDs are used at their fullest intensity, life of the LEDs is significantly reduced. It is estimated that a viable lifespan of 40,000 to 50,000 hours will be achieved under normal operational conditions. If improving on this lifespan expectancy is of a higher priority, place care in providing for lower operational temperatures. This may include climatic-environmental and the reduction of overall projection intensity.

 **CAUTION!** 
**Keep this device away from rain and moisture!
Unplug mains lead before opening the housing!**

SAFETY INSTRUCTIONS

Every person involved with the installation, operation and maintenance of this device has to:

- be qualified
- follow the instructions of this manual

 **CAUTION! Be careful with your operations.** 
**With a dangerous voltage you can suffer
a dangerous electric shock when touching the wires!**

Before your initial start-up, please make sure that there is no damage caused by transportation. Should there be any, consult your dealer and do not use the device.

To maintain perfect condition and to ensure a safe operation, it is absolutely necessary for the user to follow the safety instructions and warning notes written in this manual.

Please consider that damages caused by manual modifications to the device are not subject to warranty.

This device contains no user-serviceable parts. Refer servicing to qualified technicians only.

IMPORTANT:

The manufacturer will not accept liability for any resulting damages caused by the non-observance of this manual or any unauthorized modification to the device.

- Never let the power-cord come into contact with other cables! Handle the power-cord and all connections with the mains with particular caution!
- Never remove warning or informative labels from the unit.
- Never use anything to cover the ground contact.
- Never lift the fixture by holding it at the projector-head, as the mechanics may be damaged. Always hold the fixture at the transport handles.
- Never place any material over the lens.
- Never look directly into the light source.
- Never leave any cables lying around.
- Do not insert objects into air vents.
- Do not connect this device to a dimmerpack.
- Do not switch the device on and off in short intervals, as this would reduce the LED's life.
- Do not touch the device's housing bare-handed during its operation (housing becomes hot). Allow the fixture to cool for at least 5 minutes before handling.
- Do not shake the device. Avoid brute force when installing or operating the device.
- Only use device indoor, avoid contact with water or other liquids.
- Only operate the fixture after having checked that the housing is firmly closed and all screws are tightly fastened.
- Only operate the device after having familiarized with its functions.
- Avoid flames and do not put close to flammable liquids or gases.
- Always keep case closed while operating.
- Always allow free air space of at least 50 cm around the unit for ventilation.
- Always disconnect power from the mains, when device is not used or before cleaning! Only handle the power-cord by the plug. Never pull out the plug by tugging the power-cord.
- Make sure that the device is not exposed to extreme heat, moisture or dust.
- Make sure that the available voltage is not higher than stated on the rear panel.
- Make sure that the power-cord is never crimped or damaged. Check the device and the power-cord from time to time.
- If the lens is obviously damaged, it has to be replaced. So that its functions are not impaired, due to cracks or deep scratches.
- If device is dropped or struck, disconnect mains power supply immediately. Have a qualified engineer inspect for safety before operating.
- If the device has been exposed to drastic temperature fluctuation (e.g. after transportation), do not switch it on immediately. The arising condensation water might damage your device. Leave the device switched off until it has reached room temperature.
- If your Showtec device fails to work properly, discontinue use immediately. Pack the unit securely (preferably in the original packing material), and return it to your Showtec dealer for service.
- For adult use only. Lighteffect must be installed out of the reach of children. Never leave the unit running unattended.
- Never attempt to bypass the thermostatic switch or fuses.
- For replacement use fuses of same type and rating only.
- This device falls under protection class I. Therefore it is essential to connect the yellow/green conductor to earth.
- During the initial start-up some smoke or smell may arise. This is a normal process and does not necessarily mean that the device is defective.
- Repairs, servicing and electric connection must be carried out by a qualified technician.
- WARRANTY: Till one year after date of purchase.



CAUTION ! EYEDAMAGES !
Avoid looking directly into the light source.
(meant especially for epileptics) !



OPERATING DETERMINATIONS

- This device is not designed for permanent operation. Consistent operation breaks will ensure that the device will serve you for a long time without defects.
- The minimum distance between light-output and the illuminated surface must be more than 1 meter.
- The maximum ambient temperature $t_a = 45^\circ\text{C}$ must never be exceeded.
- If this device is operated in any other way, than the one described in this manual, the product may suffer damages and the warranty becomes void.
- Any other operation may lead to dangers like short-circuit, burns, electric shock, lamp explosion, crash etc.

You endanger your own safety and the safety of others!

Rigging

Please follow the European and national guidelines concerning rigging, trussing and all other safety issues.

Do not attempt the installation yourself !

Always let the installation be carried out by an authorized dealer !

Procedure:

- If the projector is lowered from the ceiling or high joists, professional trussing systems have to be used.
- Use a clamp to mount the projector, with the mounting-bracket, to the trussing system.
- The projector must never be fixed swinging freely in the room.
- The installation must always be secured with a safety attachment, e.g. an appropriate safety net or safety-cable.
- When rigging, derigging or servicing the projector, always make sure, that the area below the installation place is blocked and staying in the area is forbidden.

The LED Clubscanner can be placed on a flat stage floor or mounted to any kind of truss by a clamp.

Improper installation can cause serious damage to people and property !

Connection with the mains

Connect the device to the mains with the power-plug.

Always pay attention, that the right color cable is connected to the right place.

International	EU Cable	UK Cable	US Cable	Pin
L	BROWN	RED	YELLOW/COPPER	FASE
N	BLUE	BLACK	SILVER	NUL
	YELLOW/GREEN	GREEN	GREEN	EARTH

Make sure that the device is always connected properly to the earth!



Return Procedure

Returned merchandise must be sent prepaid and in the original packing, call tags will not be issued. Package must be clearly labeled with a Return Authorization Number (RMA number). Products returned without an RMA number will be refused. Highlite will not accept the returned goods or any responsibility. Call Highlite 0031-455667723 or mail aftersales@highlite.nl and request an RMA prior to shipping the fixture. Be prepared to provide the model number, serial number and a brief description of the cause for the return. Be sure to properly pack fixture, any shipping damage resulting from inadequate packaging is the customer's responsibility. Highlite reserves the right to use its own discretion to repair or replace product(s). As a suggestion, proper UPS packing or double-boxing is always a safe method to use.

Note: If you are given an RMA number, please include the following information on a piece of paper inside the box:

- 1) Your name
- 2) Your address
- 3) Your phone number
- 4) A brief description of the symptoms

Claims

The client has the obligation to check the delivered goods immediately upon delivery for any shortcomings and/or visible defects, or perform this check after our announcement that the goods are at their disposal. Damage incurred in shipping is the responsibility of the shipper; therefore the damage must be reported to the carrier upon receipt of merchandise.

It is the customer's responsibility to notify and submit claims with the shipper in the event that a fixture is damaged due to shipping. Transportation damage has to be reported to us within one day after receipt of the delivery.

Any return shipment has to be made post-paid at all times. Return shipments must be accompanied with a letter defining the reason for return shipment. Non-prepaid return shipments will be refused, unless otherwise agreed in writing.

Complaints against us must be made known in writing or by fax within 10 working days after receipt of the invoice. After this period complaints will not be handled anymore.

Complaints will only then be considered if the client has so far complied with all parts of the agreement, regardless of the agreement of which the obligation is resulting.

Description of the device

Features

The Showtec LED Clubscanner is a moving-head with high output and great effects.

- Small compact LED scanner
- Ideal for mobile DJ's and small venues
- DMX-control via standard DMX-controller
- Music Control
- Double bracket included
- High-power, 22W (1,360mA) LED
- Double bracket also suitable for floor installation
- Automatically enters stand-alone Mode, when no DMX signal is present
- Gobowheel with 14 static gobos and open
- Colourwheel with 11 vivid colours and white
- Manual Focus
- Pan 0° -- 180°
- Tilt 0° -- 90°
- Control: DMX-512, Master/Slave, Sound
- 3 pin XLR Male and Female connectors
- IEC in and IEC Out for linking multiple scanners
- Power Consumption: 40W
- Control: DMX-512, Master/Slave, Sound
- 5 DMX Channels
- Fuse F1A / 250V

Overview

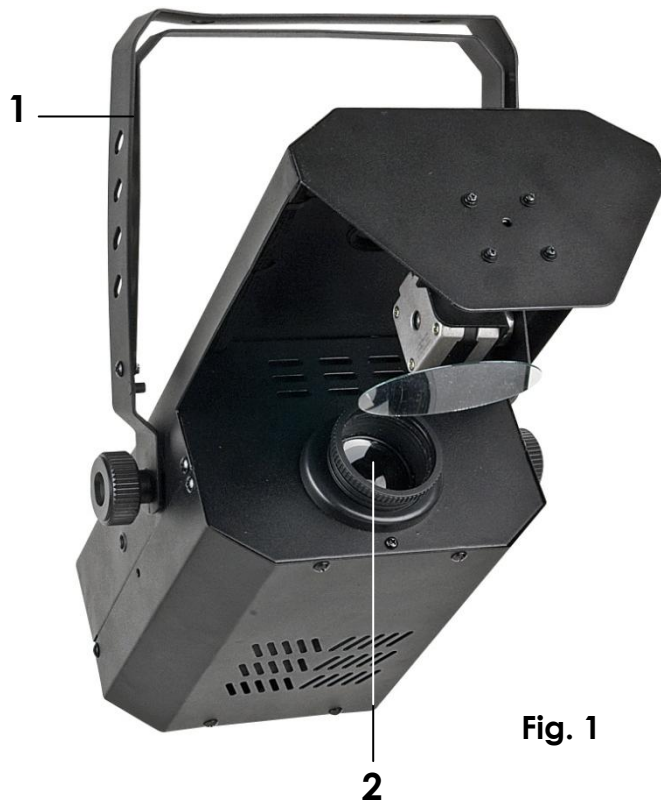

- 1) Hanging Bracket
- 2) Lens

Backside

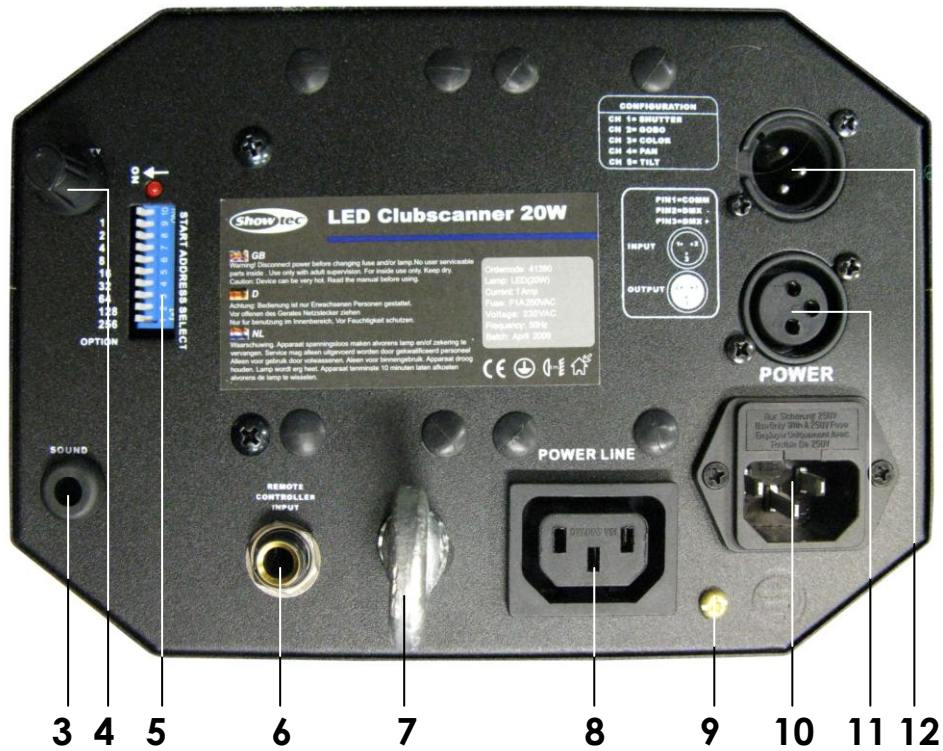

Fig. 2

- 3) Microphone
- 4) Audio Sensitivity
- 5) DMX Dipswitches
- 6) Blackout Jack Plug for connection optional Remote control (43021)
- 7) Safety eye
- 8) IEC Out
- 9) Earth
- 10) IEC In + Fuse 1A 250V
- 11) DMX signal connector (OUT) 3-pin
- 12) DMX signal connector (IN) 3-pin

Installation

Remove all packing materials from the LED Clubscanner. Check that all foam and plastic padding is removed. Connect all cables.

Do not supply power before the whole system is set up and connected properly.

Always disconnect from electric mains power supply before cleaning or servicing.

Damages caused by non-observance are not subject to warranty.

Set Up and Operation

Follow the directions below, as they pertain to your preferred operation mode.

Before plugging the unit in, always make sure that the power supply matches the product specification voltage. Do not attempt to operate a 120V specification product on 230V power, or vice versa.

Connect the device to the main power supply. The device can be music-controlled by its built-in microphone.

Control Modes

There are 3 modes:

- Sound-controlled
- Master/Slave
- DMX512 (12 Channels)

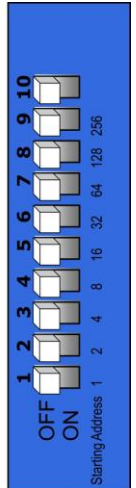

One LED Clubscanner (Sound-control)

1. Fasten the effect light onto firm trussing. Leave at least 0,5 meter on all sides for air circulation. Plug the end of the electric mains power cord into a proper electric power supply socket.
2. The dipswitces have no influence during the Sound controlled modus.
3. When the device is not connected by a DMX-cable, it functions as a stand-alone device. Turn on the music and then the LED Clubscanner will react to the beat of the music. You can also adjust the Sensitivity, by using the sensitivity control.

Multiple LED Clubscanners (Master/Slave control)

1. Fasten the effect light onto firm trussing. Leave at least 0,5 meter on all sides for air circulation.
2. Use a 3-p XLR cable to connect the LED Clubscanner. The pins:



1. Earth
2. Signal -
3. Signal +

2. The dipswitces have no influence during the Master/Slave modus.

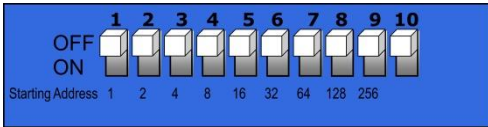

3. Link the units as shown in (Fig. 3), Connect a DMX signal cable from the first unit's DMX "out" socket to the second unit's "in" socket. Repeat this process to link the second, third, and fourth units. You can use the same sound-control function on the master device as slave devices. This means on the master device you can set your desired operation Mode and all slave devices will react the same as the master device.

Multiple LED Clubscanners (Master/Slave control)

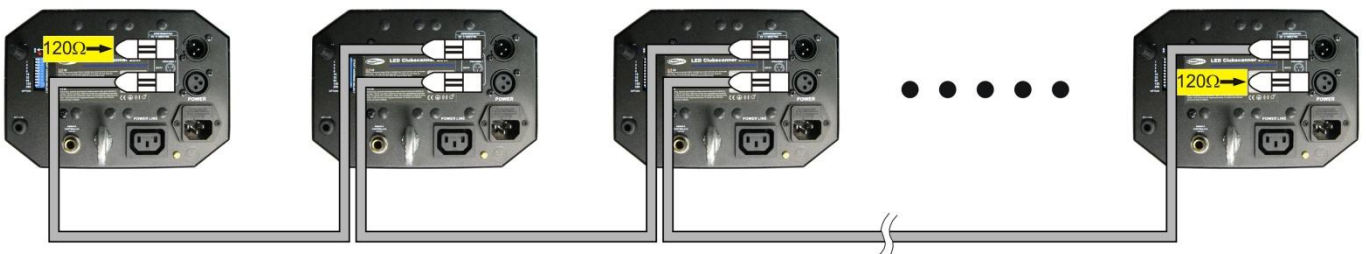

Fig. 3

Multiple LED Clubscanners (DMX Control)

1. Fasten the effect light onto firm trussing Leave at least 1 meter on all sides for air circulation.
2. Always use a safety cable (ordercode 70140 / 70141).
3. Use a 3-p XLR cable to connect the LED Clubscanners and other devices.

Occupation of the XLR-connection:

DMX-OUTPUT XLR mounting-socket:



- 1 - Ground
- 2 - Signal (-)
- 3 - Signal (+)

DMX-input XLR mounting-plug:



- 1 - Ground
- 2 - Signal (-)
- 3 - Signal (+)

The transformation of the controller line of 3 pins and 5 pins (plug and socket)

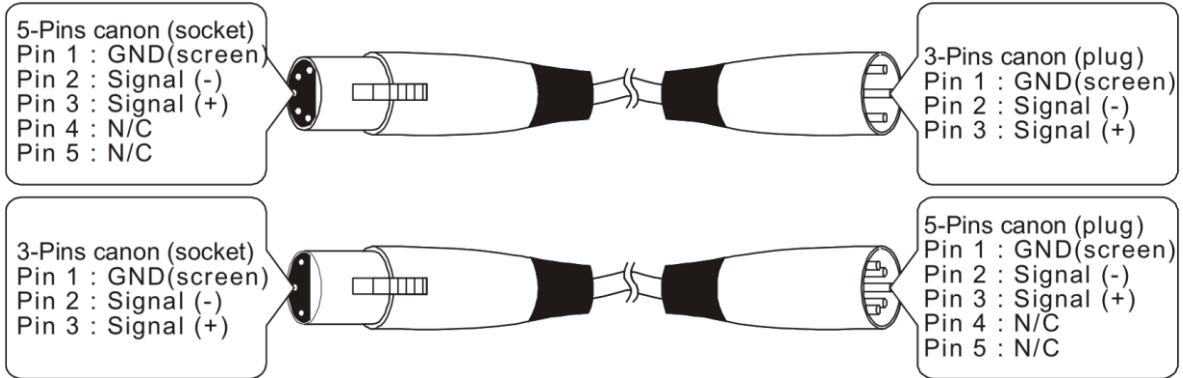

4. Link the units as shown in (figure 4), Connect a DMX signal cable from the first unit's DMX "out" socket to the second unit's "in" socket. Repeat this process to link the second, third, and fourth units.
5. Supply electric power: Plug electric mains power cords into each unit's IEC socket, then plug the other end of the mains power cord into proper electric power supply sockets, starting with the first unit. Do not supply power before the whole system is set up and connected properly.

Multiple LED Clubscanners DMX Set Up

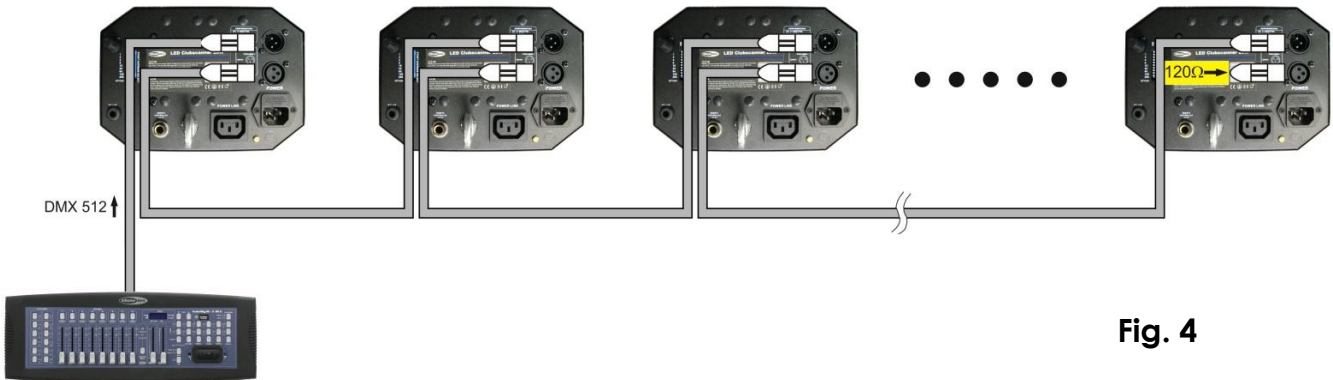

Fig. 4

Note : Link all cables and set dip switches before connecting electric power

Note: After switching on, the LED Clubscanner will automatically detect whether DMX 512 data is received or not. If there is no data received at the DMX-input, the "LED " on the control panel will not flash.

The problem may be:

- The XLR cable from the controller is not connected with the input of the LED Clubscanner.
- The controller is switched off or defective, the cable or connector is defective, or the signal wires are swapped in the input connector.

Note: It's necessary to insert a XLR termination plug (with 120 Ohm) in the last fixture in order to ensure proper transmission on the DMX data link.

Fixture Linking

You will need a serial data link to run light shows of one or more fixtures using a DMX-512 controller or to run synchronized shows on two or more fixtures set to a master/slave operating mode. The combined number of channels required by all the fixtures on a serial data link determines the number of fixtures the data link can support.

Important: Fixtures on a serial data link must be daisy chained in one single line. To comply with the EIA-485 standard no more than 30 devices should be connected on one data link. Connecting more than 30 fixtures on one serial data link without the use of a DMX optically isolated splitter may result in deterioration of the digital DMX signal.



Maximum recommended DMX data link distance: 100 meters
Maximum recommended number of LED Clubscanners on a DMX data link: 30 fixtures

Data Cabling

To link fixtures together you must obtain data cables. You can purchase DAP Audio certified DMX cables directly from a dealer/distributor or construct your own cable. If you choose to create your own cable please use data-grade cables that can carry a high quality signal and are less prone to electromagnetic interference.

DAP Audio Certified DMX Data Cables

- DAP Audio cable for allround use. bal. XLR/M 3 p. > XLR/F 3 p.
Ordercode FL01150 (1,5m.), FL013 (3m.), FL016 (6m.), FL0110 (10m.), FL0115 (15m.), FL0120 (20m.).
- DAP Audio cable for the demanding user with exceptional audio-qualities and connector made by Neutrik®. **Ordercode** FL71150 (1,5m.), FL713 (3m.), FL716 (6m.), FL7110 (10m.).

Dipswitch setting for DMX Mode

DMX products must have their own "address" to receive DMX signals. Addresses on the controller are set by flipping the appropriate DMX dip switches #1 - #9.

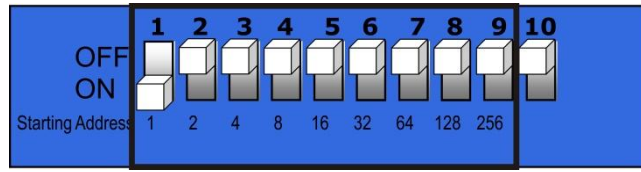

You need to know that DMX address settings are the sum of the dip switch values. A standard DMX address for a Showtec LED Clubscanner, which has 5 channels is as follow:

Example

LED Clubscanner **Address Value** **DMX Dip Switches "ON"**
 Unit 5 21 #1 , #3, #5

Switch	Value
#1	1
#3	4
#5	16 +
Total sum	21

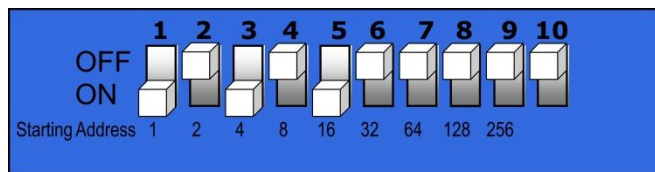

Explanation: Since each unit has 5 channels, each address advances 5 values (See Address Value above).

Once address values are determined, add DMX dip switch values to obtain the appropriate address (DMX Dip Switches "ON") for each unit. Flip appropriate DMX dip switches on each unit.

Example:

1. If you want to give an Plum Flower LED DMX address 133, you first have to find the number 133 in the DMX Chart. (See page 11)
2. Then look at the left side (Dip Switches #1-#5) horizontally from 133. In the Table you'll see #1=ON, #2=OFF, #3=ON, #4=OFF, #5=OFF.
3. Finally look at the upper side of the table (Dip Switches #6-#9) vertically from 133. In the Table you'll see #6=OFF, #7=OFF, #8=ON, #9=OFF.

DMX Address Quick Reference C

DMX DIP SWITCH SET						#9	0	0	0	0	0	0
0=OFF						#8	0	0	0	0	0	1
1=ON						#7	0	0	1	1	0	0
						#6	0	1	0	1	0	1
#1	#2	#3	#4	#5			32	64	96	128	160	
0	0	0	0	0		1	33	65	97	129	161	
0	1	0	0	0		2	34	66	98	130	162	
1	1	0	0	0		3	35	67	99	131	163	
0	0	1	0	0		4	36	68	100	132	164	
1	0	1	0	0		5	37	69	101	133	165	
0	1	1	0	0		6	38	70	102	134	166	

DMX Address Quick Reference Chart

Dip Switch Position

DMX DIP SWITCH SET 0=OFF 1=ON																							
					#9	0	0	0	0	0	0	0	0	0	1	1	1	1	1	1	1	1	
					#8	0	0	0	0	1	1	1	1	0	0	0	0	1	1	1	1	1	
					#7	0	0	1	1	0	0	1	1	0	0	1	1	0	0	1	1	1	
					#6	0	1	0	1	0	1	0	1	0	1	0	1	0	1	0	1	0	1
#1	#2	#3	#4	#5																			
0	0	0	0	0		32	64	96	128	160	192	224	256	288	320	352	384	416	448	480			
1	0	0	0	0	1	33	65	97	129	161	193	225	257	289	321	353	385	417	449	481			
0	1	0	0	0	2	34	66	98	130	162	194	226	258	290	322	354	386	418	450	482			
1	1	0	0	0	3	35	67	99	131	163	195	227	259	291	323	355	387	419	451	483			
0	0	1	0	0	4	36	68	100	132	164	196	228	260	292	324	356	388	420	452	484			
1	0	1	0	0	5	37	69	101	133	165	197	229	261	293	325	357	389	421	453	485			
0	1	1	0	0	6	38	70	102	134	166	198	230	262	294	326	358	390	422	454	486			
1	1	1	0	0	7	39	71	103	135	167	199	231	263	295	327	359	391	423	455	487			
0	0	0	1	0	8	40	72	104	136	168	200	232	264	296	328	360	392	424	456	488			
1	0	0	1	0	9	41	73	105	137	169	201	233	265	297	329	361	393	425	457	489			
0	1	0	1	0	10	42	74	106	138	170	202	234	266	298	330	362	394	426	458	490			
1	1	0	1	0	11	43	75	107	139	171	203	235	267	299	331	363	395	427	459	491			
0	0	1	1	0	12	44	76	108	140	172	204	236	268	300	332	364	396	428	460	492			
1	0	1	1	0	13	45	77	109	141	173	205	237	269	301	333	365	397	429	461	493			
0	1	1	1	0	14	46	78	110	142	174	206	238	270	302	334	366	398	430	462	494			
1	1	1	1	0	15	47	79	111	143	175	207	239	271	303	335	367	399	431	463	495			
0	0	0	0	1	16	48	80	112	144	176	208	240	272	304	336	368	400	432	464	496			
1	0	0	0	1	17	49	81	113	145	177	209	241	273	305	337	369	401	433	465	497			
0	1	0	0	1	18	50	82	114	146	178	210	242	274	306	338	370	402	434	466	498			
1	1	0	0	1	19	51	83	115	147	179	211	243	275	307	339	371	403	435	467	499			
0	0	1	0	1	20	52	84	116	148	180	212	244	276	308	340	372	404	436	468	500			
1	0	1	0	1	21	53	85	117	149	181	213	245	277	309	341	373	405	437	469	501			
0	1	1	0	1	22	54	86	118	150	182	214	246	278	310	342	374	406	438	470	502			
1	1	1	0	1	23	55	87	119	151	183	215	247	279	311	343	375	407	439	471	503			
0	0	0	1	1	24	56	88	120	152	184	216	248	280	312	344	376	408	440	472	504			
1	0	0	1	1	25	57	89	121	153	185	217	249	281	313	345	377	409	441	473	505			
0	1	0	1	1	26	58	90	122	154	186	218	250	282	314	346	378	410	442	474	506			
1	1	0	1	1	27	59	91	123	155	187	219	251	283	315	347	379	411	443	475	507			
0	0	1	1	1	28	60	92	124	156	188	220	252	284	316	348	380	412	444	476	508			
1	0	1	1	1	29	61	93	125	157	189	221	253	285	317	349	381	413	445	477	509			
0	1	1	1	1	30	62	94	126	158	190	222	254	286	318	350	382	414	446	478	510			
1	1	1	1	1	31	63	95	127	159	191	223	255	287	319	351	383	415	447	479	511			

Dip Switch Position

DMX Address

DMX Channels

Channel 1 – Shutter / Strobe (Dimmer must be open)

0-15	No Function
16-91	Adjacent color switch from slow to fast
92-135	Adjacent gobo switch from slow to fast
136-195	Adjacent color and gobo switch from slow to fast
196-255	Gobo Shake from slow to fast

Channel 2 – Static Gobo-wheel

0-7	Blackout
8-15	Open / White
16-23	Gobo 1
24-31	Gobo 2
32-39	Gobo 3
40-47	Gobo 4
48-55	Gobo 5
56-63	Gobo 6
64-71	Gobo 7
72-79	Gobo 8
80-87	Gobo 9
88-95	Gobo 10
96-103	Gobo 11
104-111	Gobo 12
112-119	Gobo 13
120-127	Gobo 14
128-255	Forwards Gobo effect from slow to fast

Channel 3 – Color-wheel

0-10	Open / White
11-21	Red
22-32	Cyan
33-43	Yellow
44-54	Green
55-65	Magenta
66-76	Light Blue
77-87	Dark Yellow
88-98	Light Green
99-109	Orange
110-120	Red/White/Blue
121-127	Yellow/Purple/Pink/Blue
128-255	Forwards rainbow effect from slow to fast

Channel 4 - Horizontal movement (Pan)

Push the slider up, in order to move head horizontally (PAN).

Gradual head adjustment from one end of the slider to the other (0-255, 128-center).

The head can be turned by 180° and stopped at any position you wish.

Channel 5 - Vertical movement (Tilt)

Push the slider, up in order to move head vertically (TILT).

Gradual head adjustment from one end of the slider to the other (0-255, 128-center).

The head can be turned by 90° and stopped at any position you wish.

Optional Remote control (43021)

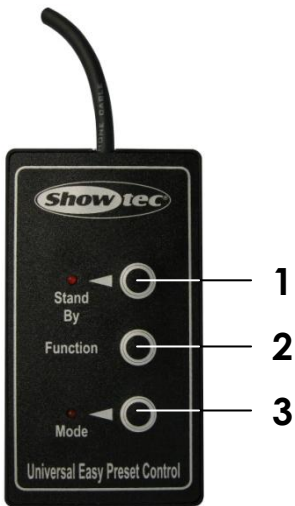

Fig. 6

1. No Function
2. Automatic Colorwheel rotation On/Off
3. Standby On/Off

Channel settings

41390 LED Clubscanner 20W Fixture-settings					
Channel	1	2	3	4	5
Function	Pan	Gobo	Color	Pan	Tilt
255	196-255 Gobo Shake from slow to fast	128-255 120-127 112-119 104-111 96-103 88-95 80-87 72-79 64-71 56-63 48-55 40-47 32-39 24-31 16-23 8-15	128-255 121-127 110-120 99-109 88-98 77-87 66-76 55-65 44-54 33-43 22-32 11-21 0-10	180° 0°	90° 0°
128	136-195 Color+Gobo Switch from slow to fast				
	92-135 Color Switch from slow to fast				
0	16-91 Gobo Switch from slow to fast				
	0-15 No Function	0-7 Blackout			

Maintenance

The operator has to make sure that safety-relating and machine-technical installations are to be inspected by an expert after every year in the course of an acceptance test.

The operator has to make sure that safety-relating and machine-technical installations are to be inspected by a skilled person once a year.

The following points have to be considered during the inspection:

1. All screws used for installing the device or parts of the device have to be tightly connected and must not be corroded.
2. There may not be any deformations on housings, fixations and installation spots.
3. Mechanically moving parts like axles, eyes and others may not show any traces of wearing.
4. The electric power supply cables must not show any damages or material fatigue.

The Showtec LED Clubscanner requires almost no maintenance. However, you should keep the unit clean.

Otherwise, the fixture's light-output will be significantly reduced. Disconnect the mains power supply, and then wipe the cover with a damp cloth. Do not immerse in liquid. Wipe lens clean with glass cleaner and a soft cloth. Do not use alcohol or solvents.

The front lens will require weekly cleaning, as smoke-fluid tends to build up residues, reducing the light-output very quickly. The cooling-fans, colour-wheel, the gobowheel, the gobos and the internal lenses should be cleaned monthly with a soft brush.

Please clean internal components once a year with a light brush and vacuum cleaner.

Keep connections clean. Disconnect electric power, and then wipe the DMX and audio connections with a damp cloth. Make sure connections are thoroughly dry before linking equipment or supplying electric power.

Replacing a Fuse

Power surges, short-circuit or inappropriate electrical power supply may cause a fuse to burn out. If the fuse burns out, the product will not function whatsoever. If this happens, follow the directions below to do so.

1. Unplug the unit from electric power source.
2. Insert a flat-head screwdriver into a slot in the fuse cover. Gently pry up the fuse cover. The fuse will come out.
3. Remove the used fuse. If brown or unclear, it is burned out.
4. Insert the replacement fuse into the holder where the old fuse was. Reinsert the fuse cover. Be sure to use a fuse of the same type and specification. See the product specification label for details.

Static Gobo-wheel



Color-wheel

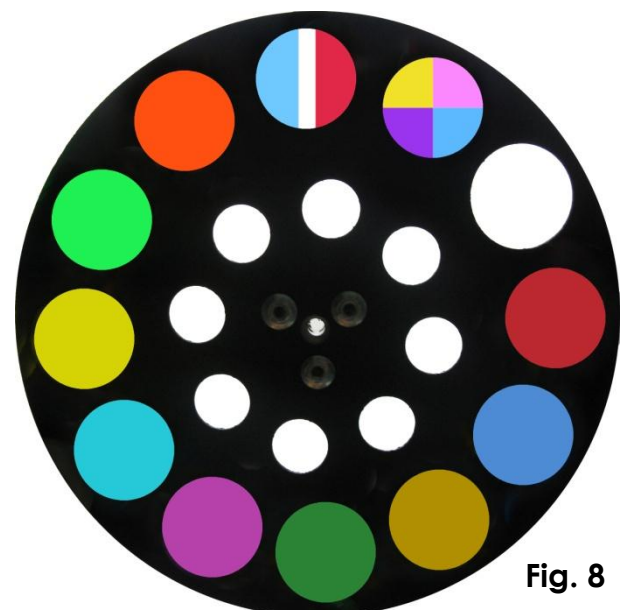

Troubleshooting

No Light, No Movement - All Products

This troubleshooting guide is meant to help solve simple problems. If a problem occurs, carry out the steps below in sequence until a solution is found. Once the unit operates properly, do not carry out following steps.

If the light effect does not operate properly, refer servicing to a technician.

Response: Suspect three potential problem areas: the power supply, the lamp, the fuse.

1. Power supply. Check that the unit is plugged into an appropriate power supply.
2. The LEDs. Return the LED Clubscanner to your Showtec dealer.
3. The fuse. Replace the fuse. See page 15 for replacing the fuse.

No Response to DMX

Response: Suspect the DMX cable or connectors, a controller malfunction, a light effect DMX card malfunction.

1. Check the DMX cable: Unplug the unit; change the DMX cable; then reconnect to electrical power. Try your DMX control again.
2. Determine whether the controller or light effect is at fault. Does the controller operate properly with other DMX products ? If not, take the controller in for repair. If so, take the DMX cable and the light effect to a qualified technician.

See next page for more problem solving.

Problem	Probable cause(s)	Remedy
One or more fixtures are completely dead.	No power to the fixture	· Check that power is switched on and cables are plugged in.
	Primary fuse blown.	· Replace fuse.
Fixtures reset correctly, but all respond erratically or not at all to the controller.	The controller is not connected.	· Connect controller.
	3-pin XLR Out of the controller does not match XLR Out of the first fixture on the link (i.e. signal is reversed).	· Install a phase reversing cable between the controller and the first fixture on the link.
Fixtures reset correctly, but some respond erratically or not at all to the controller.	Poor data quality	· Check data quality. If much lower than 100 percent, the problem may be a bad data link connection, poor quality or broken cables, missing termination plug, or a defective fixture disturbing the link.
	Bad data link connection	· Inspect connections and cables. Correct poor connections. Repair or replace damaged cables.
	Data link not terminated with 120 Ohm termination plug.	· Insert termination plug in output jack of the last fixture on the link.
	Incorrect addressing of the fixtures.	· Check address setting.
	One of the fixtures is defective and disturbs data transmission on the link.	· Bypass one fixture at a time until normal operation is regained: unplug both connectors and connect them directly together. · Have the defective fixture serviced by a qualified technician.
	3-pin XLR Out on the fixtures does not match (pins 2 and 3 reversed).	· Install a phase-reversing cable between the fixtures or swap pin 2 and 3 in the fixture, that behaves erratically.
Shutter closes suddenly	The color wheel, gobo wheel, or a gobo has lost its index position and the fixture is resetting the effect.	· Contact a technician for servicing if the problem persists.
No light	The power supply settings do not match local AC voltage and frequency.	· Disconnect fixture. Check settings and correct if necessary.
	LEDs damaged	· Disconnect fixture and return to your dealer.
LED Lamp cuts out intermittently.	Fixture is too hot.	· Allow fixture to cool. · Clean fan. · Make sure air vents at control panel and front lens are not blocked. · Turn up the air conditioning.
	The power supply settings do not match local AC voltage and frequency.	· Disconnect fixture. Check settings and correct if necessary.

Product Specification

Model: Showtec LED Clubscanner
Voltage: 240V-50Hz (CE)
Power Consumption: 22W
Fuse: 1 A / 250V
Dimensions: 410x200x140mm (LxWxH)
Weight: 3,86 kg

Operation and Programming

Signal pin OUT: pin 1 earth, pin 2 (-), pin 3 (+)
Set Up and Addressing: LED control panel
DMX Channels: 5
Signal input 3-pin XLR male
Signal output 3-pin XLR female

Electro-mechanical effects

Music Control
Gobowheel with 14 static gobos and open
Colourwheel with 11 vivid colours and white
Manual Focus
Pan 0° -- 180°
Tilt 0° -- 90°
Control: DMX-512, Master/Slave, Sound

Gobos

Colourwheel: heat-resistant and intensify glass; dichroic glass coating
Max. ambient temperature t_a : 40°C; Max. housing temperature t_B : 80°C
Cooling: 1 fan in the projector
Motor: high quality stepping-motor controlled by microprocessors

Minimum distance:

Minimum distance from flammable surfaces: 0.5m
Minimum distance to lighted object: 1.3m



Design and product specifications are subject to change without prior notice.



Website: www.Showtec.info
Email: service@highlite.nl



© 2009 Showtec.