

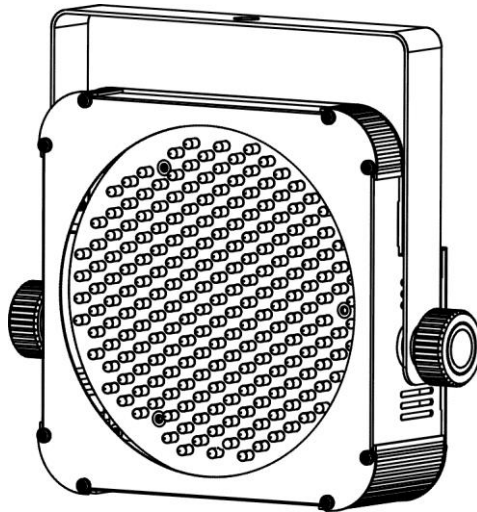

LED PANEL



LED-212RGB

User Manual

Please read the instructions carefully before use

TABLE OF CONTENTS

1. Safety Instructions
2. Technical Specifications
3. Installation
4. How to set the unit
5. How to control the fixture
6. DMX512 Configuration
7. DMX512 Connections
8. Troubleshooting
9. Fixture Cleaning

1. Safety Introductions



WARNING

Please read the instructions carefully which includes important information about the installation, operation and maintenance.

- Please keep this User Manual for future consultation. If you sell the fixture to another user, be sure that they also receive this instruction booklet.
- Unpack and check carefully there is no transportation damage before using the fixture.
- Before operating, ensure that the voltage and frequency of power supply match the power requirements of the fixture.
- It's important to ground the yellow/green conductor to earth in order to avoid electric shock.
- Disconnect main power before servicing and maintenance.
- Use safety chain when fixes this fixture. Don't handle the fixture by taking its head only, but always by taking its base.
- Maximum ambient temperature is $T_a : 40^{\circ}\text{C}$. Don't operate it where the temperature is higher than this.
- In the event of serious operating problem, stop using the fixture immediately. Never try to repair the fixture by yourself. Repairs carried out by unskilled people can lead to damage or malfunction. Please contact the nearest authorized technical assistance center. Always use the same type spare parts.
- Do not connect the device to any dimmer pack.
- Do not touch any wire during operation and there might be a hazard of electric shock.
- To prevent or reduce the risk of electrical shock or fire, do not expose the fixture to rain or moisture.
- The housing must be replaced if they are visibly damaged.
- Do not look directly at the LED light beam while the fixture is on.

Warning

For power supply, do not connect in series much more than 31 units, use another mains supply for next 31 units.

- To prevent or reduce the risk of electrical shock or fire, do not expose the unit to rain or

moisture.

- Do not open the unit within five minutes after switching off.
- The housing, the lenses, or the ultraviolet filter must be replaced if they are visibly damaged.

Caution

There are no user serviceable parts inside the fixture. Do not open the housing or attempt any repairs yourself. In the unlikely situation, your unit may require service, please contact your nearest dealer.

2. Technical Specifications

- **LED:** total 212pcs, Red 70pcs, Green 71pcs, Blue 71pcs
- **Power supply**
Input Voltage: AC 100V-240V~50/60Hz
Power consumption: 20W
- **Beam Angle:** 15°
- **Fuse:** T 6.3A
- **Dimension:** 272 x 67 x 252 mm
- **Weight:** 1.8kgs

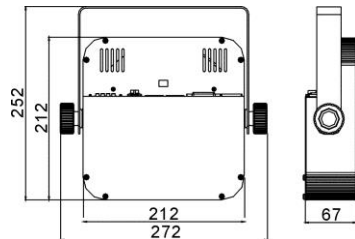

3. Installation

The unit should be mounted via its screw holes on the bracket. Always ensure that the unit is firmly fixed to avoid vibration and slipping while operating. Always ensure that the structure to which you are attaching the unit is secure and is able to support a weight of 10 times of the unit's weight. Also always use a safety cable that can hold 12 times of the weight of the unit when installing the fixture.

The equipment must be fixed by professionals. And it must be fixed at a place where is out of the touch of people and has no one pass by or under it.

4. How To Set The Unit

4.1 Control Panel

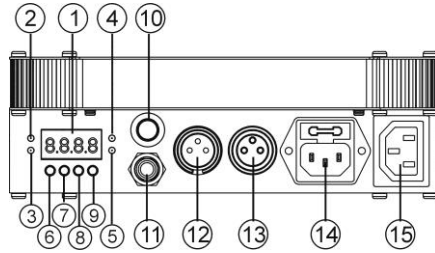

① **Display:** To show the various menus and the selected functions

LED:

② DMX	On	DMX input present
③ MASTER	On	Master Mode
④ SLAVE	On	Slave Mode
⑤ SOUND	Flashing	Sound activation

Button:

⑥ MENU	To select the programming functions
⑦ DOWN	To go backward in the selected functions
⑧ UP	To go forward in the selected functions
⑨ ENTER	To confirm the selected functions

⑩ **Microphone:** Receive music for the sound active.

⑪ **Only for remote control:** By connect to the 1/4" microphone jack to control the unit for Stand by, Function and Mode function.

⑫ **DMX output:** For DMX512 link, use 3/5-pin XLR plug cable to link the next unit.

⑬ **DMX input:** For DMX512 link, use 3/5-pin XLR plug cable to input DMX signal.

⑭ **Mains input:** Connect to supply mains power.

⑮ **Mains output:** Connect to supply mains power for the next unit.

4.2 Main Function

To select any of the given functions, press the **MENU** button up to the required one is shown on the display. Select the function by **ENTER** button and the display will blink. Use **DOWN** and **UP** button to change the mode. Once the required mode has been selected, press the **ENTER** button to setup or it will automatically return to the main functions without any change after idling 8 seconds. To go back to the functions without any change press the **MENU** button. The main functions are shown below:

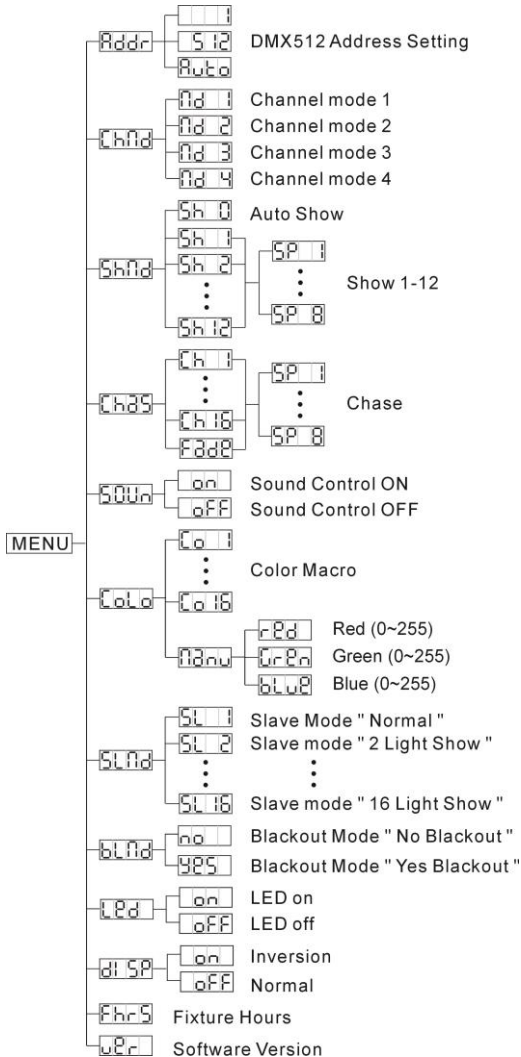

Addr DMX 512 Address Setting

Press the **MENU** button up to when the **Addr** is shown on the display. Press **ENTER** button and the display will blink. Use **DOWN** and **UP** button to change the DMX512 address or select **Auto** (auto setting) mode. Once select, press the **ENTER** button to store or automatically return to the main functions without any change after 8 seconds. To go back to the functions without any change press the **MENU** button again.

Chnd Channel mode

Press the **MENU** button up to when the **Chnd** is shown on the display. Pressing **ENTER** button and the display will blink. Use **DOWN** and **UP** button to select the **nd 1** (channel 1) or **nd 2** (channel 2) or **nd 3** (channel 3) or **nd 4** (channel 4) mode. Once the mode has been selected, press the **ENTER** button to setup or automatically return to the main functions without any change after 8 seconds. To go back to the functions without any change press the **MENU** button again.

Shnd Show Mode

Press the **MENU** button up to when the **Shnd** is shown on the display. Pressing **ENTER** button and the display will blink. Use **DOWN** and **UP** button to select the **Sh 0** (auto show) or **Sh 1** (show 1) or **Sh 2** (show 2) or ... **Sh 12** (show 12). Once the show has been selected, press the **ENTER** button to confirm, if you select **Sh 1** (show 1) or **Sh 2** (show 2) or ... **Sh 12** (show 12), you can press **DOWN** and **UP** button to select **SP 1** (slowest) or ... **SP 8** (fastest), press **ENTER** button to store or automatically return to the main functions without any change after 8 seconds. To go back to the functions without any change press the **MENU** button again.

Chas Chase Mode

Press the **MENU** button up to when the **Chas** is shown on the display. Pressing **ENTER** button and the display will blink. Use **DOWN** and **UP** button to select the **Ch 1** (chase 1) or ... or **Ch 16** (chase 16) or **Fade** (fade). Once the chase has been selected, press the **ENTER** button to confirm, then press **DOWN** and **UP** button to select **SP 1** (slowest)

or ... **SP 8** (fastest), press **ENTER** button to store or automatically return to the main functions without any change after 8 seconds. To go back to the functions without any change press the **MENU** button again.

SOUN Sound control

Press the **MENU** button up to when the **SOUN** is shown on the display. Pressing **ENTER** button and the display will blink. Use **DOWN** and **UP** button to select the **ON** (sound control on) or **OFF** (sound control off). Once the mode has been selected, press the **ENTER** button to setup or automatically return to the main functions without any change after 8 seconds. To go back to the functions without any change press the **MENU** button again.

CoLo Color Mode



Press the **MENU** button up to when the **CoLo** is shown on the display. Pressing **ENTER** button and the display will blink. Use **DOWN** and **UP** button to select the **Co 1** (color 1) or ... or **Co 16** (show 16) or **MANU** (manual setting). Once select, press the **ENTER** button to confirm, if you select **MANU** (manual setting), you can press **DOWN** and **UP** button to select **red** (red) or **Green** (green) or **blue** (blue), press **ENTER** button to confirm, then use **DOWN** and **UP** button to adjust the value (0-255) and press **ENTER** button to store, automatically return to the main functions without any change after 8 seconds. To go back to the functions without any change press the **MENU** button again.

SLND Slave Mode

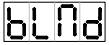
Press the **MENU** button up to when the **SLND** is shown on the display. Pressing **ENTER** button and the display will blink. Use **DOWN** and **UP** button to select the **SL 1** (normal) or ... or **SL 16** (16 light show) mode. Once the mode has been selected, press the **ENTER** button to setup or automatically return to the main functions without any change after 8 seconds. To go back to the functions without any change press the **MENU** button again.





Blackout Mode

Press the **MENU** button up to when the  is shown on the display. Pressing **ENTER** button and the display will blink. Use **DOWN** and **UP** button to select the  (no blackout) or  (yes blackout) mode. Once the mode has been selected, press the **ENTER** button to setup or automatically return to the main functions without any change after 8 seconds. To go back to the functions without any change press the **MENU** button again.





Led Display

Press the **MENU** button up to when the  is shown on the display. Pressing **ENTER** button and the display will blink. Use **DOWN** and **UP** button to select the  (Led on) or  (Led off) mode. Once the mode has been selected, press the **ENTER** button to setup or automatically return to the main functions without any change after 8 seconds. To go back to the functions without any change press the **MENU** button again.



Display Inversion

It is good for you to install the unit on the floor or under ceiling. Press the **MENU** button up to when the  is shown on the display. Pressing **ENTER** button and the display will blink. Use **DOWN** and **UP** button to select the  (display inversion) or  (display normal). Once select, press the **ENTER** button to setup or automatically return to the main functions without any change after 8 seconds. To go back to the functions without any change press the **MENU** button again.

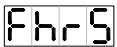

Fixture Hours

Press the **MENU** button up to when the  is blinking on the display. Pressing **ENTER** button and the display will show the number of working hours of the unit. To go back to the functions press the **MENU** button again.

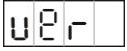

Software version

Press the **MENU** button up to when the  is blinking on the display. Pressing **ENTER** button and the display will show the version of software of the unit. To go back to the functions press the **MENU** button again.

5. How to control the fixture

There are three ways to control the fixture

- A. Universal DMX controller
- B. Master/Slave operation
- C. Easy controller (by CA-8)

A. Universal DMX controller

The fixture can be set the DMX address remotely by universal DMX controller. First, you need to programming two scenes into a chase, and then link the fixtures to the universal DMX controller. When you run the chase, all the fixtures of the chain will be set the series DMX address automatically. The fixture uses four channels. Please refer to the following diagram to set the address for the first four units.



B. Master/Slave operation

The fixture will allow you to link 16 fixtures together and operate without a controller. In Master/Slave mode, the first fixture will control the others to give an automatic, sound activated, synchronized light show. This function is good when you want an instant show. The first fixture it's DMX input cable will have nothing connect it, and the other fixtures will be set in slave mode automatically. Their DMX input cables connect the last fixture DMX output cable (daisy chain). Any fixture can act as a Master or as a Slave

C. Easy Controller (by CA-8)

The easy remote control is used only in master/slave mode. There is a terminator for connect the easy controller inside the fixture. By connecting the cable into DMX IN waterproof cable entry gland to the CA-8 terminator of the first fixture, you will find that the remote control on the first fixture will control all the other fixtures for Stand by, Function and Mode functions.

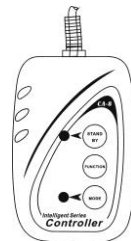

Blackout	To blackout all the fixture			
Function	Strobe 1. Synchronous strobe in white color 2. The same color chase 3. Different color strobe	Select Color Color 1-16 or manual setting color	Select show Show 1-12	Select Chase Chase 1-16 or fade
Mode	Sound 1 (LED OFF)	Manual (LED ON)	Sound 2 (LED slow blinking)	Auto (LED fast blinking)

6. DMX512 Configuration

DMX512 Configuration						
Ch1	Ch2	Ch3	Ch4			
RED	GREEN	BLUE	DIMMER/STROBE (Mode1)	DIMMER (Mod2)	DIMMER/STROBE (Mode3)	DIMMER/STROBE (Mode4)

7. DMX512 Connections

The DMX512 is widely used in intelligent lighting control, with a maximum of 512 channels.

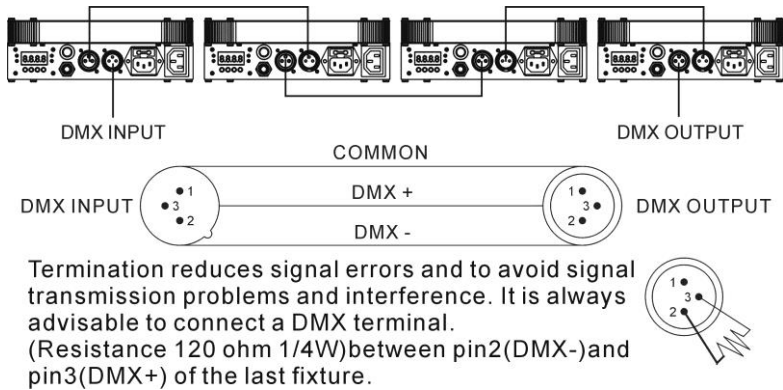

1. If you using a controller with 5 pins DMX output, you need to use a 5 to 3 pin adapter-cable.
2. Connect the fixture together in a “daisy chain” by XLR plug cable from the output of the fixture to the input of the next fixture. The cable cannot be branched or split to a “Y” cable. Inadequate or damaged cables, soldered joints or corroded connectors can easily distort the signal and shut down the system
3. The DMX output and input connectors are pass-through to maintain the DMX circuit when one of the units’ power is disconnected.
4. At last fixture, the DMX cable has to be terminated with a terminator to reduce signal errors. Solder a 120-ohm 1/4W resistor between pin 2(DMX-) and pin 3(DMX+) into a 3-pin XLR-plug and plug it in the DMX-output of the last fixture.
5. Each lighting fixture needs to have an address set to receive the data sent by the controller. The address number is between 0-511 (usually 0 & 1 are equal to 1).
6. 3 pin XLR connectors are more popular than 5 pin XLR.
3 pin XLR: Pin1: GND, Pin2: Negative signal (-), Pin3: Positive signal (+)
5 pin XLR: Pin1: GND, Pin2: Negative signal (-), Pin3: Positive signal (+)
Pin4/5: Not Used.

8. Troubleshooting

Following are a few common problems that may occur during operation. Here are some suggestions for easy troubleshooting:

A. The fixture does not work, no light

1. Check the connection of power and main fuse.
2. Measure the mains voltage on the main connector.

B. Not responding to DMX controller

1. DMX LED should be on. If not, check DMX connectors, cables to see if link properly.
2. If the DMX LED is on and no response to the channel, check the address settings and DMX polarity.
3. If you have intermittent DMX signal problems, check the pins on connectors or on PCB of the fixture or the previous one.
4. Try to use another DMX controller.
5. Check if the DMX cables run near or run alongside to high voltage cables that may cause damage or interference to DMX interface circuit.

C. Some fixtures don't respond to the easy controller

1. You may have a break in the DMX cabling. Check the LED for the response of the master/ slave mode signal.
2. Wrong DMX address in the fixture. Set the proper address.

D. No response to the sound

1. Make sure the fixture does not receive DMX signal.
2. Check microphone to see if it is good by tapping the microphone.

E. One of the channels is not working well

1. The stepper motor might be damaged or the cable connected to the PCB is broken.
2. The motor's drive IC on the PCB might be out of condition.

9. Fixture Cleaning

The cleaning of internal must be carried out periodically to optimize light output. Cleaning frequency depends on the environment in which the fixture operates: damp, smoky or particularly dirty surrounding can cause greater accumulation of dirt on the fixture's optics.

- Clean with soft cloth using normal glass cleaning fluid.
- Always dry the parts carefully.
- Clean the external optics at least every 20 days. Clean the internal optics at least every 30/60 days.

EC Declaration of Conformity

We declare that our products (lighting equipments) comply with the following specification and bears CE mark in accordance with the provision of the Electromagnetic Compatibility (EMC) Directive 89/336/EEC.

EN55103-1:199601-2; EN55103-2:1996;
EN61000-3-2:2000+A2:2005;
EN61000-3-3:1995+A1:2001+A2:2005.

&

Harmonized Standard

EN 60598-1: 2004
IEC 60598-1:2003+ corrigendum 2004
Part 1:General requirements and test

Following the provisions of the low voltage directive 73/23/EEC and 93/68/EEC

Innovation, Quality, Performance